

Low Signal Relay

G5V-1

Ultra-miniature, Highly Sensitive SPDT Relay for Signal Circuits

- High sensitivity: 150 mW nominal power consumption.
- Small size at 10 H x 7.5 W x 12.5 L mm.
- Switches from 1 mA to 1 A.
- Conforms to FCC part 68 requirements for coil to contacts.
- Fully-sealed construction.
- Ideal for use in telecommunications, security, and computer/peripheral equipment.
- RoHS Compliant.

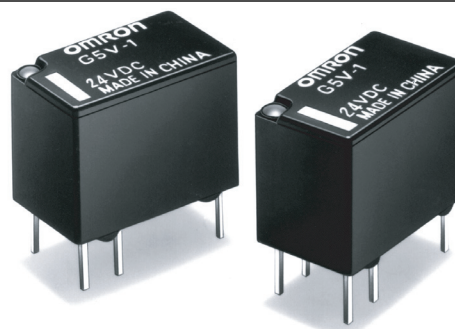

Ordering Information

To Order: Select the part number and add the desired coil voltage rating (e.g., G5V-1-DC12).

Terminal	Type	Contact form	Contact type	Construction	Model
PCB through-hole	Standard	SPDT	Single crossbar	Fully sealed	G5V-1

Model Number Legend

G5V - - DC

1 2 3

1. Contact Form
1: SPDT

2. Pickup Voltage %
Blank: Standard, 80% of nominal

3. Rated Coil Voltage
3, 5, 6, 9, 12, 24 VDC

Specifications

■ Contact Data

Load	Resistive load (p.f. = 1)
Rated load	0.50 A at 125 VAC, 1A 24 VDC
Contact material	Ag + Au-Alloy
Carry current	2 A
Max. operating voltage	125 VAC, 60 VDC
Max. operating current	1 A
Max. switching capacity	62.50 VA, 30W
Min. permissible load (See note)	1 mA, 5 VDC

Note: P level: $\lambda_{60} = 0.1 \times 10^{-6}$ /operation

This value was measured at a switching frequency of 120 operations/min and the criterion of contact resistance is 100 Ω . This value may vary depending on the operating environment. Always double-check relay suitability under actual operating conditions.

■ Coil Data

Rated voltage (VDC)	Rated current (mA)	Coil resistance (Ω)	Coil inductance (Ref. value) (H)		Pick-up voltage	Dropout voltage	Maximum voltage	Power consumption (mW)
			Armature OFF	Armature ON				
3	50	60	0.05	0.11	80%	10% min.	200% at 23°C	Approx. 150
5	30	167	0.15	0.29				
6	25	240	0.20	0.41				
9	16.70	540	0.45	0.93				
12	12.50	960	0.85	1.63				
24	6.25	3,840	3.48	6.61				

- Note:**
1. The rated current and coil resistance are measured at a coil temperature of 23°C with a tolerance of ±10%.
 2. The operating characteristics are measured at a coil temperature of 23°C.
 3. The maximum voltage is the highest voltage that can be imposed on the relay coil.

■ Characteristics

Contact resistance (See note 1)		100 mΩ max.
Operate time (See note 2)		5 ms max. (mean value: approx. 2.50 ms)
Release time (See note 2)		5 ms max. (mean value: approx. 0.90 ms)
Operating frequency (max.)	Mechanical	36,000 operations/hour
	Electrical	1,800 operations/hour
Insulation resistance (See note 3)		1,000 MΩ min. (at 500 VDC between coil and contacts, at 250 VDC between contacts of same polarity)
Dielectric strength		1,000 VAC, 50/60 Hz for 1 minute between coil and contacts 400 VAC, 50/60 Hz for 1 minute between contacts of same polarity
Impulse withstand voltage		1,500 V (10 X 160 μs) between coil and contacts (conforms to FCC Part 68)
Vibration	Mechanical durability	10 to 55 Hz, 3.30 mm double amplitude
	Malfunction durability	
Shock	Mechanical durability	1,000 m/s ² (approx. 100G)
	Malfunction durability	100 m/s ² (approx. 10 G)
Ambient temperature		-40°C to 70°C
Humidity		5% to 85% RH
Service life	Mechanical	5 million operations min. (at 18,000 operations/hour)
	Electrical	100,000 operations min. (under rated load, 1,800 ops/hr) See "Characteristic Data"
Weight		Approx. 2 g

- Note:**
1. The contact resistance was measured with 10 mA at 1 VDC with a fall-of-potential method.
 2. Values in parentheses are typical values unless otherwise stated.
 3. The insulation resistance was measured with a 500-VDC Megohmmeter between coil and contacts and a 250 VDC megohmmeter between contacts with the same polarity applied to the same parts as those for checking the dielectric strength.
 4. The above values are initial values.

■ Approvals

UL Recognized (File No. E41515) / CSA Certified (File No. LR31928) - - Ambient Temp. = 40°C

Type	Contact form	Coil rating	Contact ratings	Number of test operations
G5V-1	SPDT	3 to 24 VDC	0.5A at 125 VAC (General Use)	100,000
			0.3 A at 110 VDC (Resistive)	6,000
			1A at 30 VDC (Resistive)	

Note: In the interest of product improvement, specifications are subject to change.

Characteristic Data

Maximum Switching Capacity

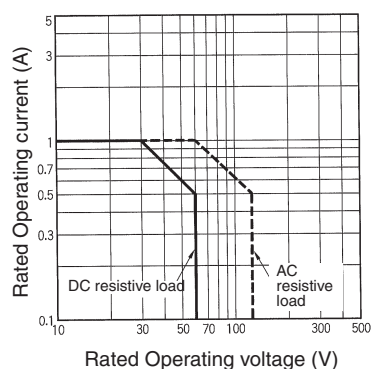

Electrical Service Life

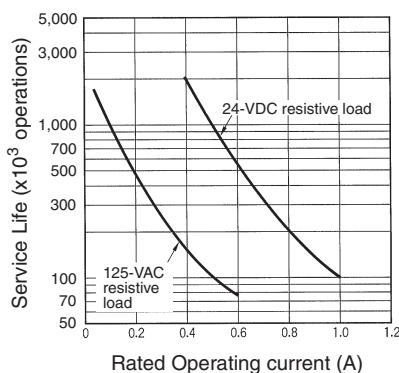

Ambient Temperature vs. Maximum Coil Voltage

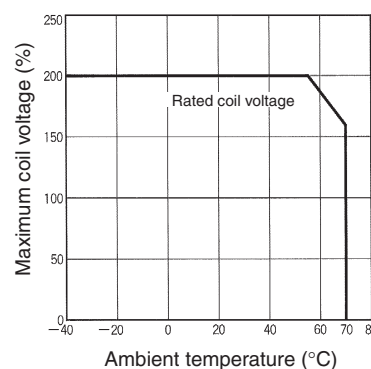

Note: The maximum coil voltage refers to the maximum value in a varying range of operating power voltage, not a continuous voltage.

Dimensions

- Note:**
- All units are in millimeters unless otherwise indicated. To convert millimeters into inches, multiply by 0.03937.
 - Numbers in parentheses are reference values.
 - Tolerance: ± 0.1
 - Orientation marks are indicated as follows:

G5V-1

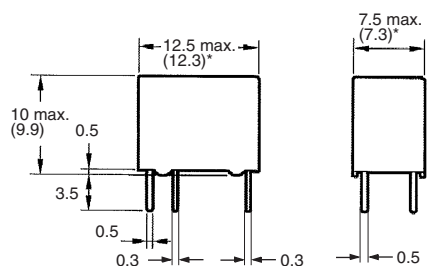
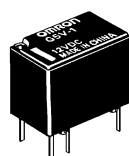

Terminal Arrangement/ Internal Connections (Bottom View)

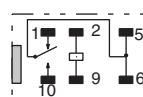

Mounting Holes (Bottom View)

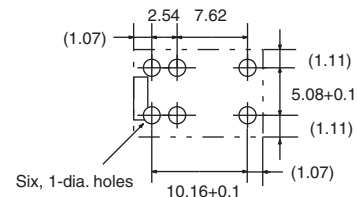

Precautions

Long-term Continuously ON Contacts

Using the Relay in a circuit where the Relay will be ON continuously for long periods (without switching) can lead to unstable contacts, because the heat generated by the coil itself will affect the insulation, causing a film to develop on the contact surfaces. Be sure to use a fail-safe circuit design that provides protection against contact failure or coil burnout.

Relay Handling

When washing the product after soldering the Relay to a PCB, use a water-based solvent or alcohol-based solvent, and keep the solvent temperature to less than 40°C. Do not put the Relay in a cold cleaning bath immediately after soldering.