



WESTCODE SEMICONDUCTORS

Technical
Publication
TR219C

Issue 2
December 1985

High Frequency Inverter Grade Capsule Thyristor Type R219C

distributed amplified gate for high di/dt and low switching losses

690 amperes average: up to 1200 volts V_{RRM}/V_{DRM}

Ratings (Maximum values at 125°C Tj unless stated otherwise)

RATING	CONDITIONS	SYMBOL	
Average on-state current	Half sine wave { 55°C heatsink temperature (double side cooled) 85°C heatsink temperature (single side cooled)	$I_{T(AV)}$	690 A
			240 A
R.M.S. on-state current	25°C heatsink temperature, double side cooled	$I_{T(RMS)}$	1430 A
Continuous on-state current	25°C heatsink temperature, double side cooled	I_T	1100 A
Peak one-cycle surge (non-repetitive) on state current	10ms duration, 60% V_{RRM} re-applied 10ms duration, $V_R \leq 10$ volts	$I_{TSM(1)}$	9000 A
		$I_{TSM(2)}$	9900 A
Maximum permissible surge energy	10ms duration, $V_R \leq 10$ volts 3ms duration, $V_R \leq 10$ volts	$I^2t(2)$	490000 A ² s
		I^2t	353000 A ² s
Peak forward gate current	Anode positive with respect to cathode	I_{FGM}	36 A
Peak forward gate voltage	Anode positive with respect to cathode	V_{FGM}	16 V
Peak reverse gate voltage		V_{RGM}	5 V
Average gate power		P_G	2 W
Peak gate power	100μs. pulse width	P_{GM}	120 W
Rate of rise of off-state voltage	To 80% V_{DRM} gate open-circuit	dv/dt	*200 V/μs
Rate of rise of on-state current (repetitive)	{ Gate drive 20 volts, 20 ohms with $t_r \leq 1\mu s.$ Anode voltage $\leq 80\% V_{DRM}$	di/dt (1)	1000 A/μs
Rate of rise of on-state current (non-repetitive)		di/dt (2)	1500 A/μs
Operating temperature range		T_{hs}	-40 + 125°C
Storage temperature range		T_{stg}	-40 + 150°C

Characteristics (Maximum values at 125°C Tj unless stated otherwise)

CHARACTERISTIC	CONDITIONS	SYMBOL	
Peak on-state voltage	At 1400 A, I_{TM}	V_{TM}	2.04 V
Forward conduction threshold voltage		V_O	1.55 V
Forward conduction slope resistance		r	0.35 mΩ
Repetitive peak off-state current	At V_{DRM}	I_{DRM}	70 mA
Repetitive peak reverse current	At V_{RRM}	I_{RRM}	70 mA
Maximum gate current required to fire all devices	{ At 25°C, $V_A = 10$ V, $I_A = 2$ A }	I_{GT}	300 mA
Maximum gate voltage required to fire all devices		V_{GT}	3 V
Maximum holding current		I_H	1 A
Maximum gate voltage which will not trigger any device		V_{GD}	0.25 V
Stored charge	$I_{TM} = 1000$ A, dir/dt 60A/μs $V_{RM} = 50$ V, 50% chord value	Q_{rr}	85 μC
Circuit commutated turn-off time available down to	$I_{TM} = 1000$ A dir/dt = 60A/μs, $V_{RM} = 50$ V { 200V/μs to 80% V_{DRM} 20V/μs to 80% V_{DRM}	tq	15-25 μs
Thermal resistance, junction to heat sink, for a device with a maximum forward volt drop characteristic	Double side cooled Single side cooled	tq typical $R_{th(j-hs)}$	10-20 μs 0.047°C/W 0.094°C/W

VOLTAGE CODE	H02	H04	H06	H08	H10	H12			
Repetitive peak voltages Non-repetitive peak off-state voltage	V_{RRM}	V_{DRM}	V_{DSM}	200	400	600	800	1000	1200
Non-repetitive peak reverse blocking voltage	V_{RSM}	300	500	700	900	1100	1300		

Ordering Information (Please quote device code as explained below)

R	2	1	9	C	●	●	●	●	0
Fixed type code	Voltage Code (see ratings)	dv/dt code to 80% V_{DRM} C = 20V/μs E = 100V/μs D = 50V/μs F = 200V/μs		Turn-off time J = 25 μs K = 20 μs L = 15 μs N = 10 μs					

Typical code: R219CH06FK0 = 600 V_{RRM} 600 V_{DRM} 200 V/μs dv/dt to 80% V_{DRM} 20 μs turn-off

*Other values of dv/dt up to 1000 V/μs, and turn-off time may be available.

9000-3990

1. INTRODUCTION

The R219C series of thyristors incorporates diffused silicon slices, 38 mm in diameter in cold-weld housings. Fast turn-on, with low turn-on loss is achieved by interdigitation of the cathode.

2. NOTES ON THE RATINGS

(a) Rate of rise of on-state current

The maximum un-primed rate of rise of on-state current must not exceed $1500 \text{ A}/\mu\text{s}$ at any time during turn-on on a non-repetitive basis. For repetitive performance the on-state rate of rise of current must not exceed $1000 \text{ A}/\mu\text{s}$ at any time during turn-on. Note that these values of current rate of rise apply to the circuit external to the device and its specified snubber network and device current rates of rise will be higher.

(b) Square wave ratings

These ratings are given for leading edge linear rates of rise of forward current of 100 and $500 \text{ A}/\mu\text{s}$.

(c) Duty Cycle Lines

The 100% duty cycle line appears on all these ratings. These frequency ratings are presented in the form that all duty cycles may be represented by straight parallel lines.

(d) Maximum operating Frequency

The maximum operating frequency, f_{max} , is set by the time required for the thyristor to turn off (t_q) and for the off-state voltage to reach full value (t_v), i.e.

$$f_{\text{max}} = \frac{1}{t_{\text{pulse}} + t_q + t_v}$$

(e) Energy per pulse characteristics

These curves enable rapid estimation of device dissipation to be obtained for conditions not covered by the frequency ratings.

Let E_p be the Energy per pulse for a given current and pulse width, in joules.

Then $W_{\text{AV}} = E_p \times f$.

3. REVERSE RECOVERY LOSS

On account of the number of circuit variables affecting reverse recovery voltage, no allowance for reverse recovery loss has been made in these ratings. The following procedure is recommended for use where it is necessary to include reverse recovery loss.

(a) Determination by Measurement

From waveforms of recovery current obtained from a high frequency shunt (see Note 1) and reverse voltage present during recovery, an instantaneous reverse recovery loss waveform must be constructed. Let the area under this waveform be A joules per pulse. A new heat sink temperature can then be evaluated from:

$$T_{\text{SINK}}(\text{new}) = T_{\text{SINK}}(\text{original}) - A \left(\frac{r_t \cdot 10^6}{t} + R_{\text{th}} \times f \right)$$

where $r_t = 8.53 \times 10^{-5} \sqrt{t}$

t = duration of reverse recovery loss per pulse in microseconds

A = Area under reverse loss waveform per pulse in joules (W.S.)

f = rated frequency at the original heat sink temperature

The total dissipation is now given by

$$W_{(\text{TOT})} = W_{(\text{original})} + A \times f$$

(b) Design Method

In circumstances where it is not possible to measure voltage and current conditions, or for design purposes, the additional losses may be estimated from figure 7. A typical R-C snubber network is connected across the thyristor to control the transient reverse voltage waveform.

Let E be the value of energy per reverse cycle in joules (figure 7).

Let f be the operating frequency in Hz

then $T_{\text{SINK}} \text{ new} = T_{\text{SINK}} \text{ original} - ER_{\text{th}} \times f$

where $T_{\text{SINK}} \text{ new}$ is the required maximum heat sink temperature

and $T_{\text{SINK}} \text{ original}$ is the heat sink temperature given with the frequency ratings.

4. GATE DRIVE

The recommended gate drive is 20 V, 20 ohms with a short-circuit current rise time of not more than $1 \mu\text{s}$. This gate drive must be applied when using the full di/dt capability of the device.

5. THE DV/DT SUPPRESSION NETWORK

The effect of a conventional resistor-capacitor snubber of $0.1 \mu\text{F}$ 10 ohms has been included in these ratings and all rating di/dt values apply to the circuit external to the thyristor and its suppression network.

Snubber Network Values

A series connected C-R filter may be required across the anode to cathode terminals of the thyristor for the purpose of reducing off-state voltage overshoot.

The optimum values for C and R depend partly on the circuits connected to the thyristor. For most applications the snubber design values should not exceed a maximum of $0.1 \mu\text{F}$ or a minimum of 10 ohms. Please consult Westcode for values outside these limits.

6. NOTE 1

REVERSE RECOVERY LOSS BY MEASUREMENT

This thyristor has a low reverse recovered charge and peak reverse recovery current. When measuring the charge care must be taken to ensure that:

- a.c. coupled devices such as current transformers are not affected by prior passage of high amplitude forward current.
- The measuring oscilloscope has adequate dynamic range — typically 100 screen heights — to cope with the initial forward current without overload.

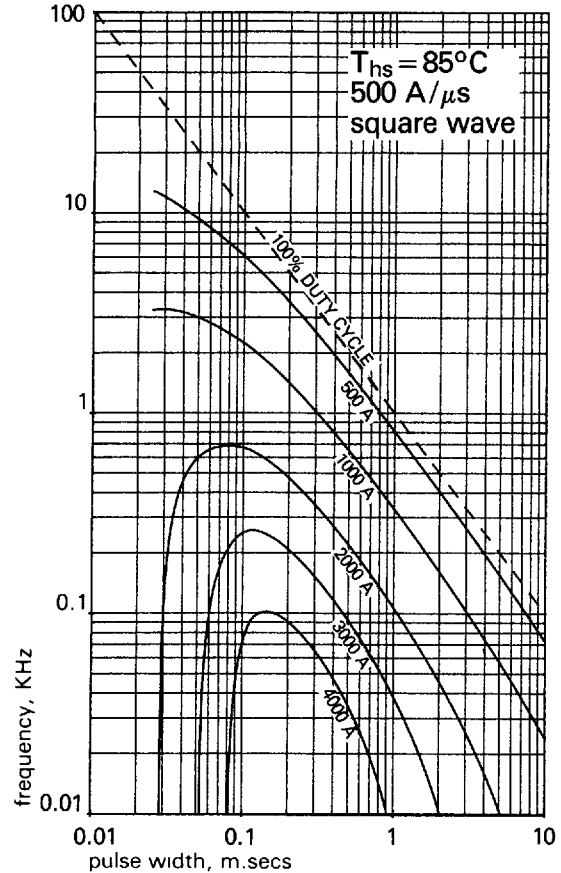

Figure 1 Frequency v. pulse width

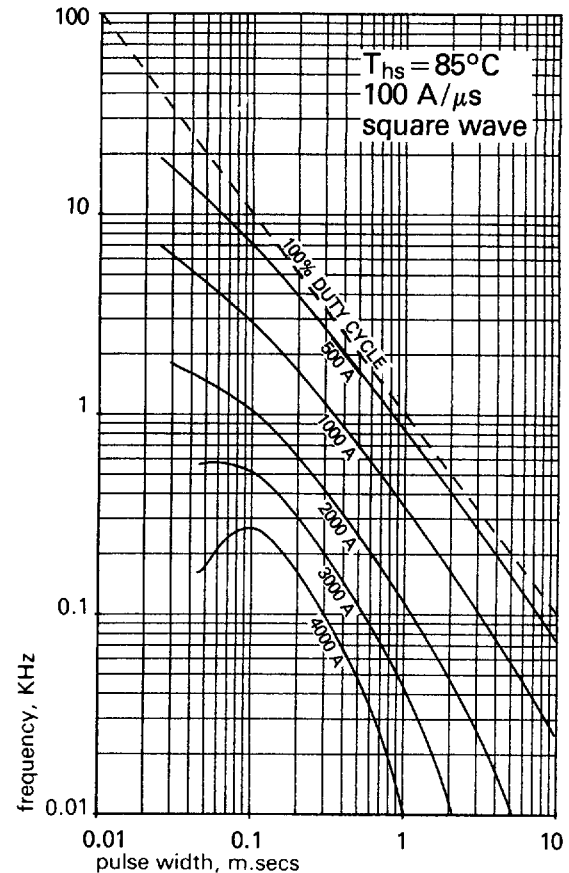

Figure 2 Frequency v. pulse width

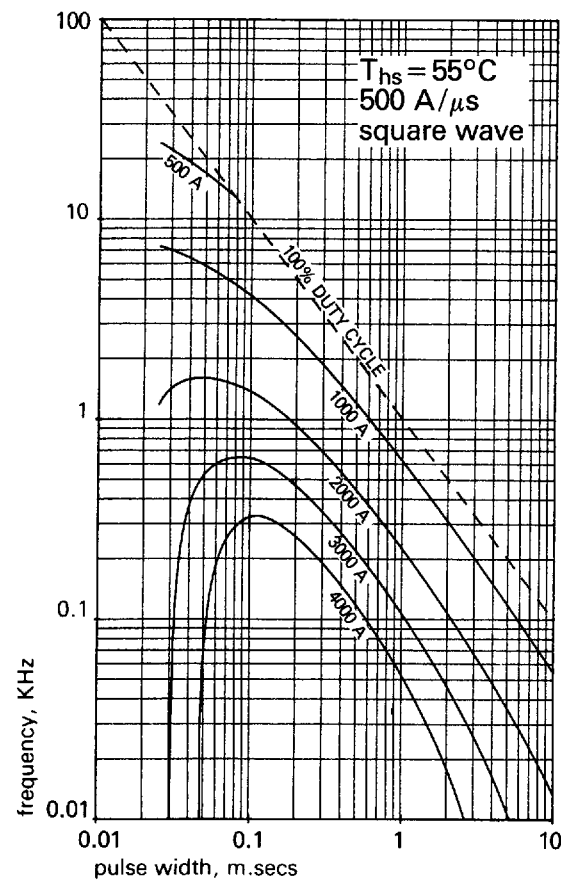

Figure 3 Frequency v. pulse width

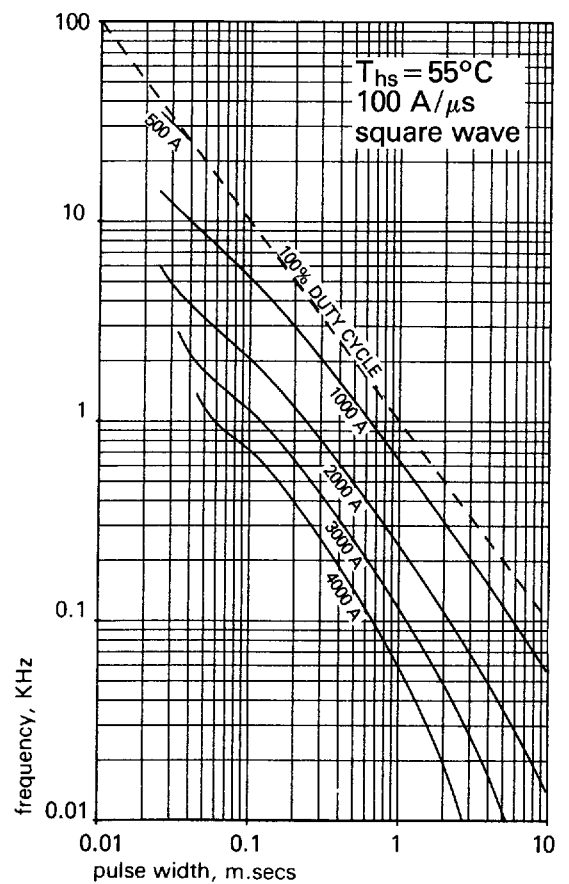

Figure 4 Frequency v. pulse width

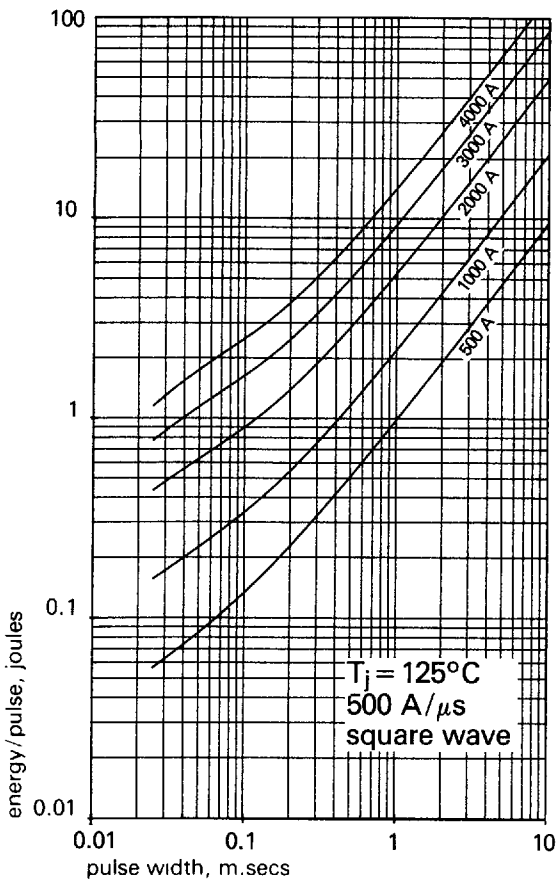

Figure 5 Energy/pulse v. pulse width

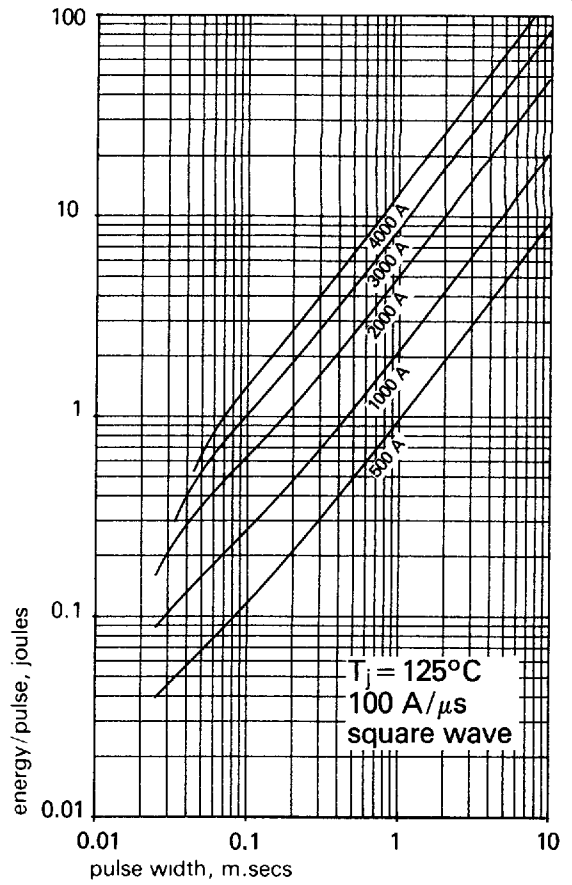

Figure 6 Energy/pulse v. pulse width

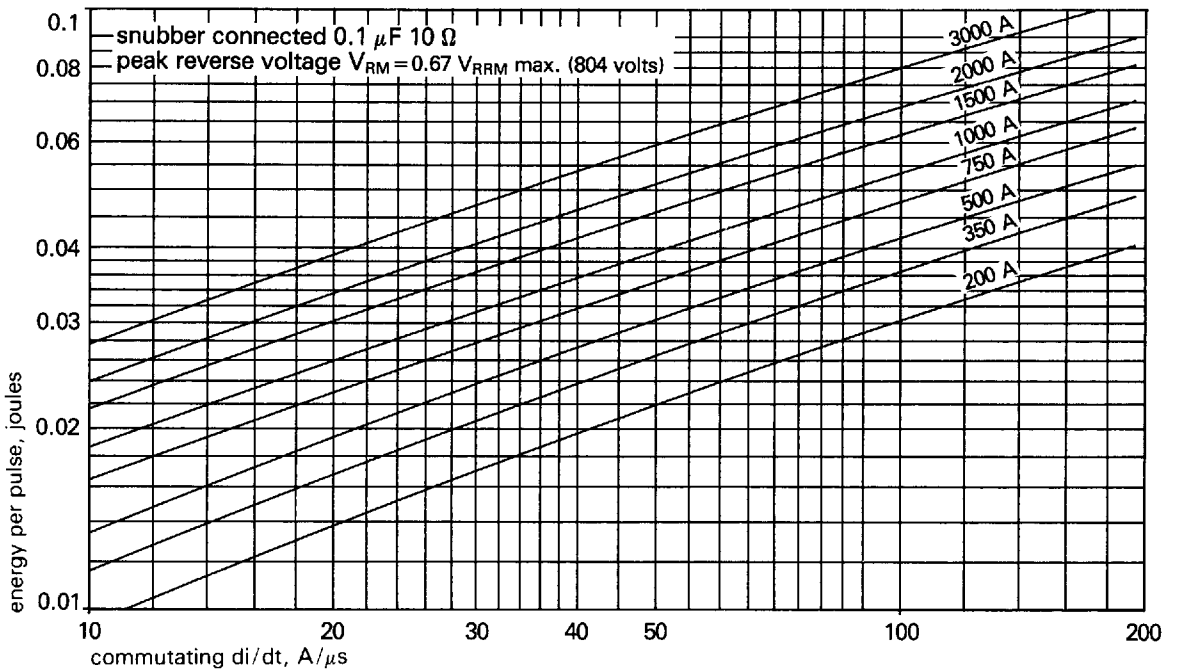

Figure 7 Max. reverse recovery energy loss per pulse at 125°C junction temperature and $V_{RM} = 804$ volts

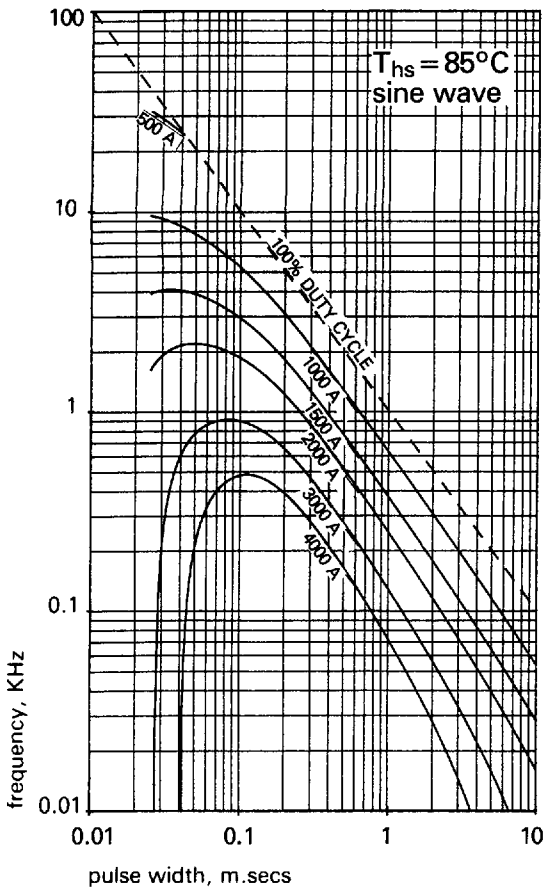

Figure 8 Frequency v. pulse width

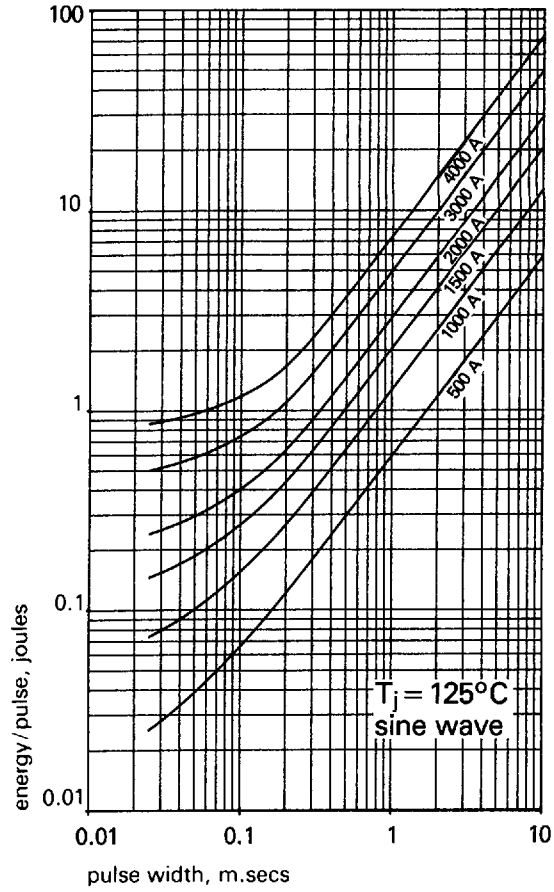

Figure 9 Energy/pulse v. pulse width

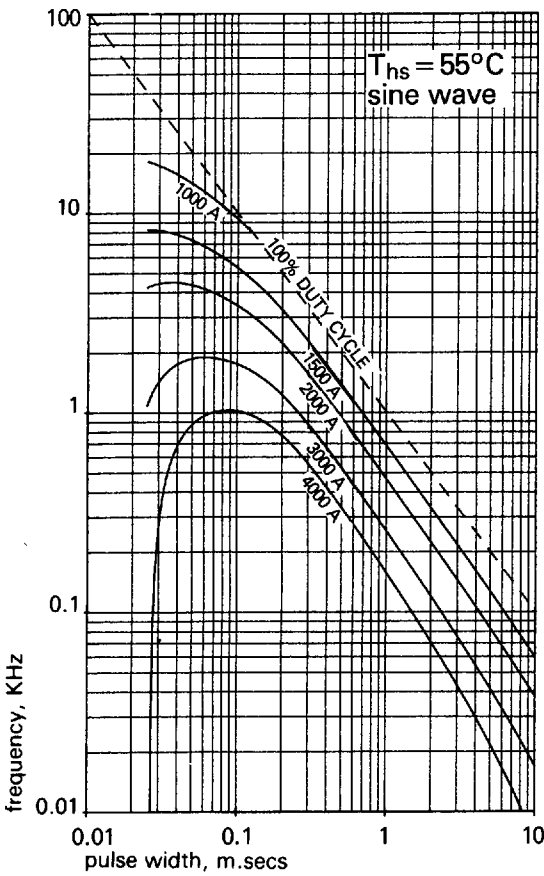

Figure 10 Frequency v. pulse width

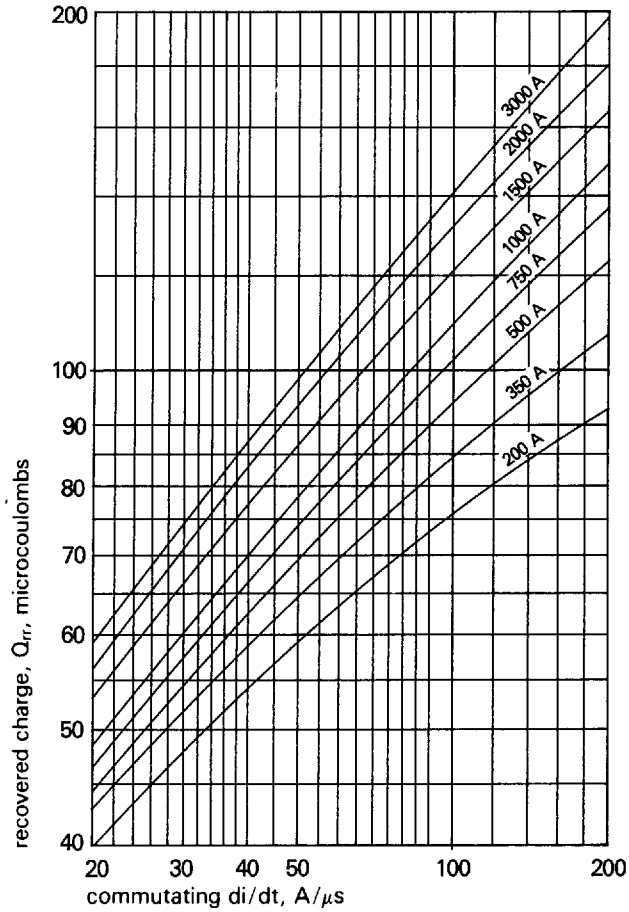

Figure 11 Maximum recovered charge at 125°C junction temperature

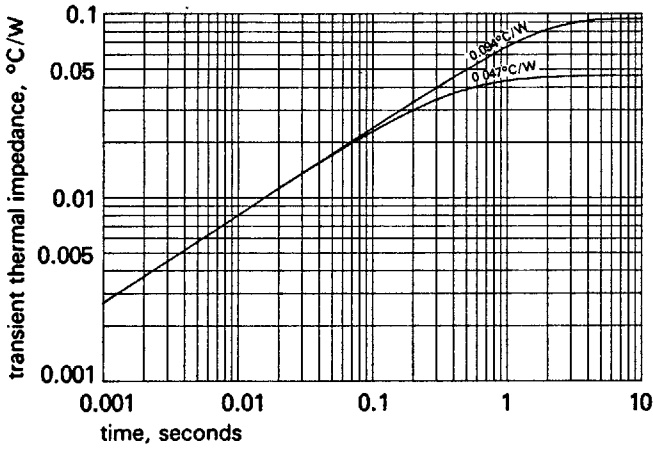

Figure 12 Junction to heatsink transient thermal impedance

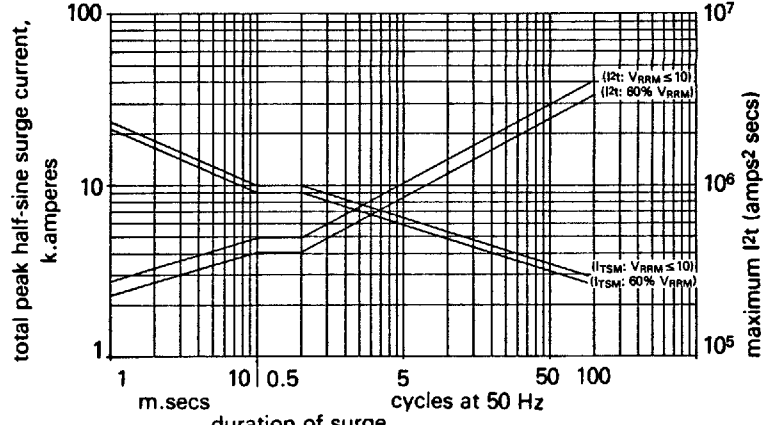

Figure 13 Max. non-repetitive surge current at initial junction temperature 125°C (gate may temporarily lose control of firing angle) Note: This rating must not be interpreted as an intermittent rating

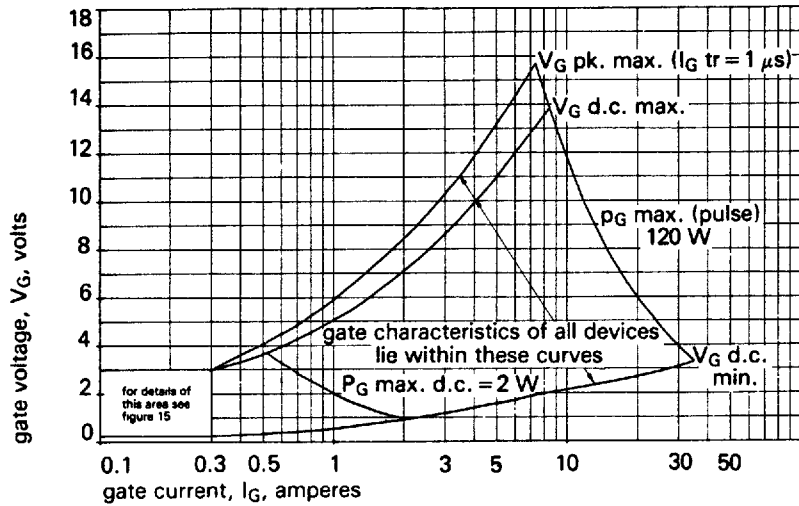

Figure 14 Gate characteristics at 25°C junction temperature

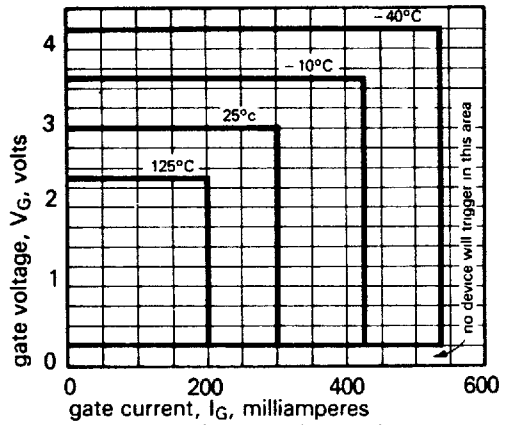

Figure 15 Gate triggering characteristics. Trigger points of all thyristors lie within the areas shown Gate drive load line must lie outside appropriate I_G/V_G rectangle

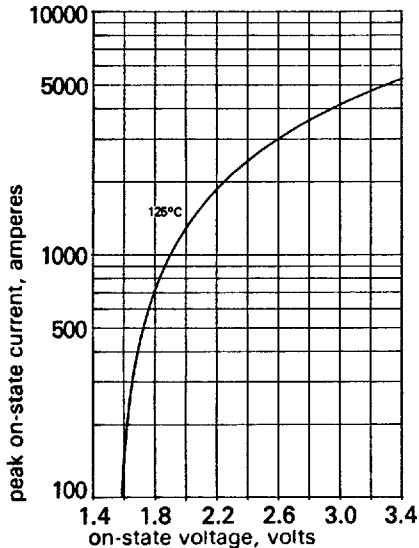
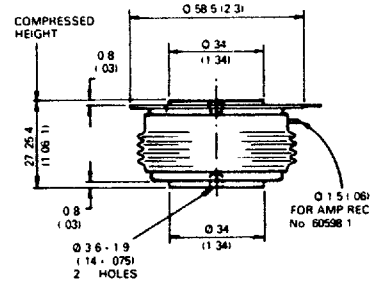
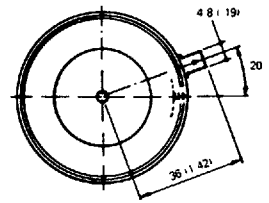

Figure 16 Limit on-state characteristic

WESTCODE SEMICONDUCTORS

dimensions in mm (inches)
Mounting force: 1000-2000 kgf
Weight: 340 grams



TO - 200AC

In the interest of product improvement, Westcode reserves the right to change specifications at any time without notice.

WESTCODE SEMICONDUCTORS LTD

P.O. Box 57 Chippenham Wiltshire SN15 1JL England
Telephone Chippenham (0249) 654141 Telex 44751

HAWKER SIDDELEY

Westinghouse Brake and Signal Co. Ltd.

